

CCA3 Curb with (Optional) Security Bars

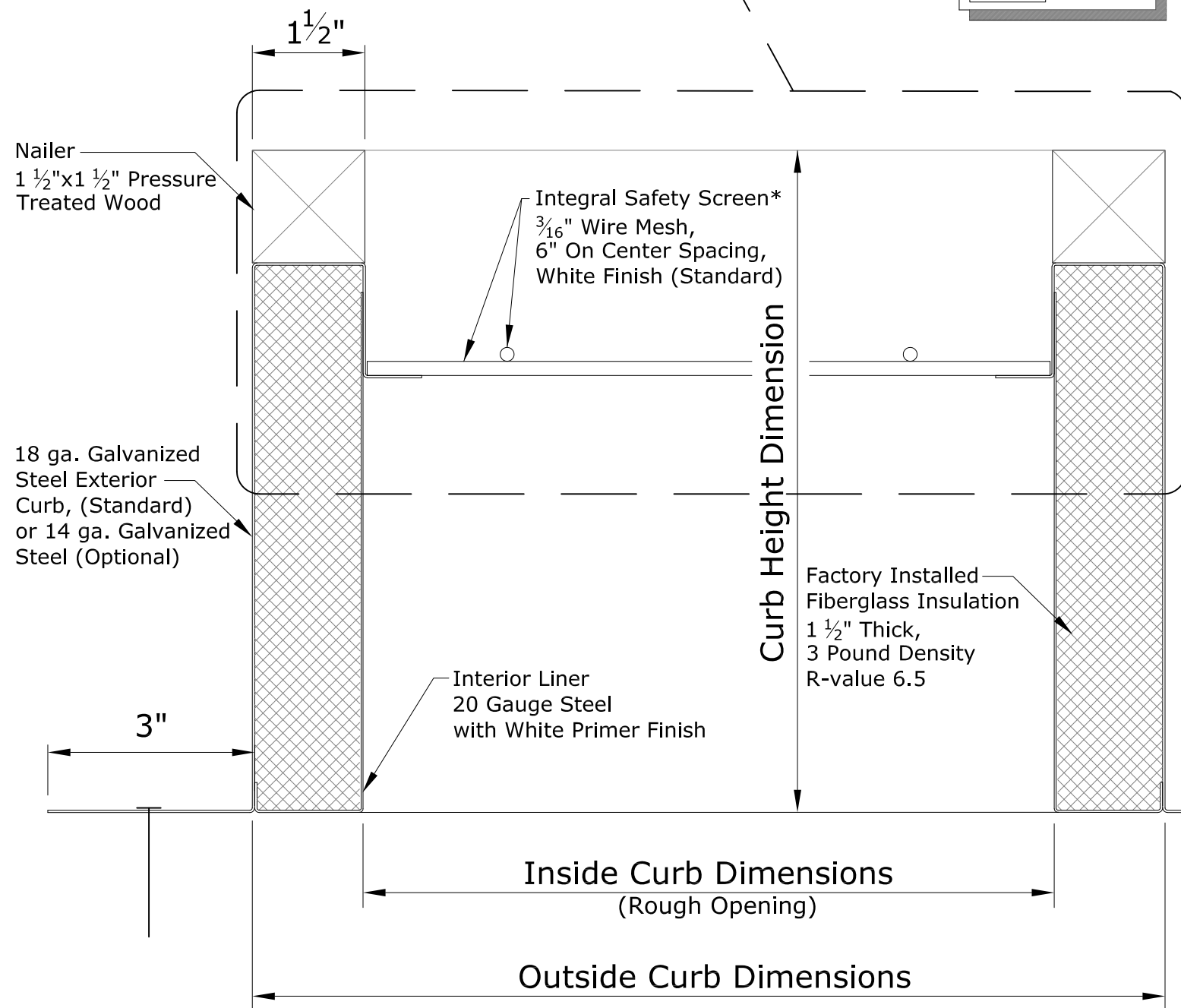

CCA3 Curb Quantities, Sizing & Options

Quantity	Size	Dimensions				Options				
		Inside Curb (Rough Opening)	Outside Curb	Curb Height				14 ga. Steel Curb	No Safety Screen*	Security Bars
				9"	12"	16"	18"			
	2424	19"x19"	22"x22"							
	2828	22.25"x22.25"	25.25"x25.25"							
	2836	22.25"x30.25"	25.25"x33.25"							
	2852	22.25"x46.25"	25.25"x49.25"							
	3636	30.25"x30.25"	33.25"x33.25"							
	3652	30.25"x46.25"	33.25"x49.25"							
	3676	30.25"x69.5"	33.25"x72.5"							
	4242	37"x37"	40"x40"							
	4280	37"x75"	40"x78"							
	5252	46.25"x46.25"	49.25"x49.25"							
	5276	46.25"x69.25"	49.25"x72.25"							
	5284	46.25"x78.25"	49.25"x81.25"							
	5296	46.25"x89.25"	49.25"x92.25"							
	5555	48"x48"	51"x51"							
	55102	48"x96"	51"x99"							
	6060	55"x55"	58"x58"							
	6476	57.5"x69.5"	60.5"x72.5"							
	6496	57.5"x89.5"	60.5"x92.5"							
	6666	60"x60"	63"x63"							
	66102	60"x96"	63"x99"							
	7272	68"x68"	71"x71"							
	8080	75"x75"	78"x78"							
	9898	92.5"x92.5"	95.5"x95.5"							
	Custom									
	Custom									

*Note: The CCA3 Curb is normally furnished with an Integral Safety Screen as the Standard offering. If no Safety Screen is required, it must be specified in the Options.

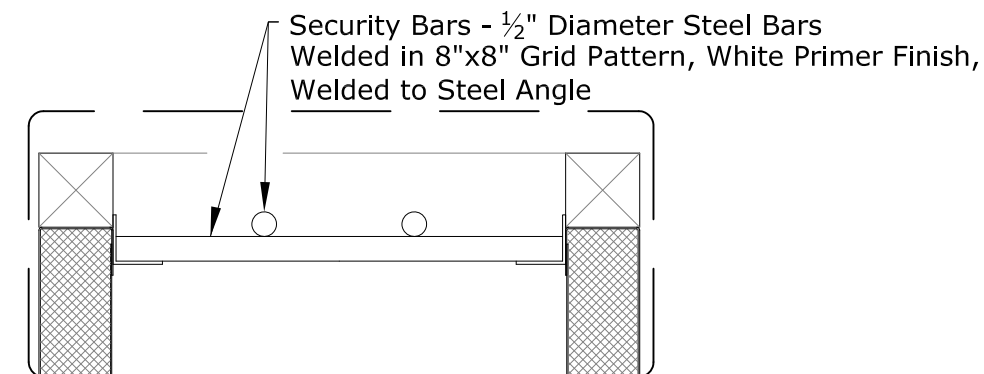

CCA3 Curb with (Optional) Security Bars

GENERAL NOTES

1. This drawing emphasizes the VELUX CCA3 Curb. This presentation illustrates a basic cross section for a VELUX CCA3 Curb utilized with a VELUX Commercial Dome installation in a 0-60 degree roof pitch application.
2. The architectural/structural design and specifications for the inclusion of a curb, such as the VELUX CCA3, in any roofing/ceiling application is determined and provided by others. The design criteria includes, but is not limited to design loads, structural configurations, structural framing member sizes and material, architectural finishes and integration with the roofing/ceiling systems of the building. VELUX recommends compliance by all designers and installers with all local and industry specific building codes and guidelines. VELUX assumes no responsibility or liability in the design, construction and performance of a building structure by others.

This drawing is an instrument of service and is provided for informational use only.



Sky-Global Product Management

VELUX America LLC
85 Spencer Drive
Wells, ME 04090
800-888-3589
www.wascoskylights.com

CCA3 Curb