

# ZZZ 199

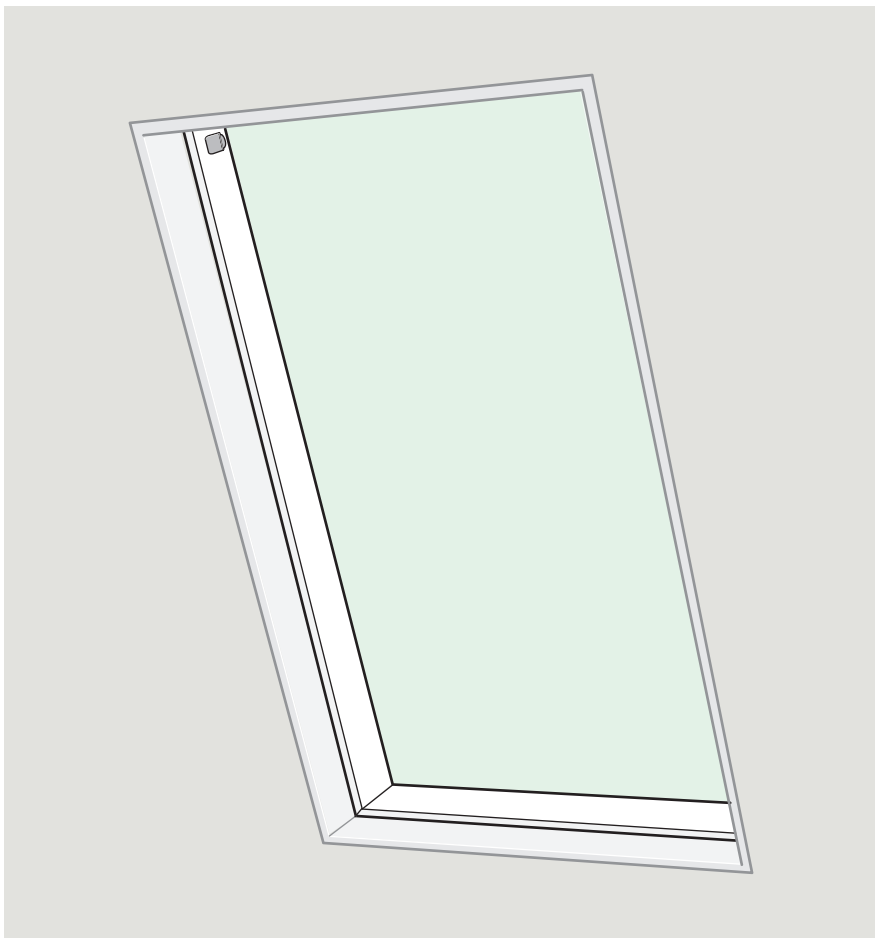

**ENGLISH:** FCM Accessory Tray Installation Instructions

**ESPAÑOL:** Instrucciones de instalación de la bandeja de FCM

**FRANÇAIS :** Instructions d'installation du plateau d'accessoires pour FCM



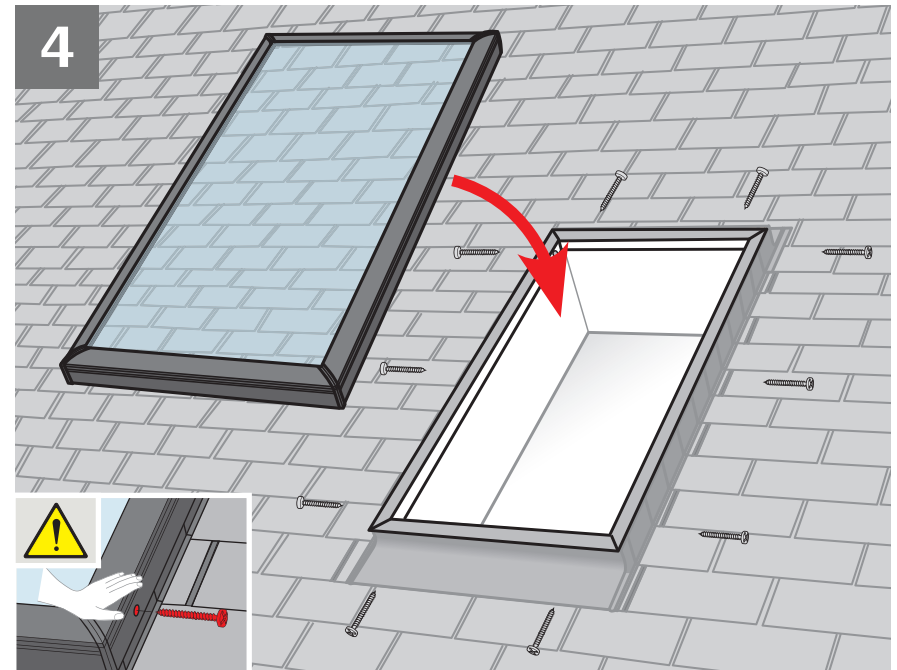
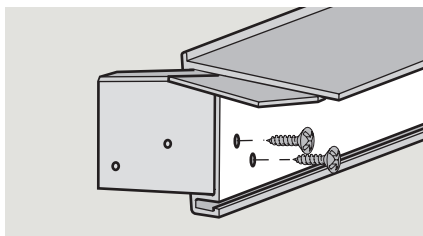
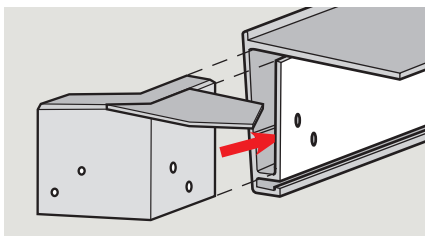
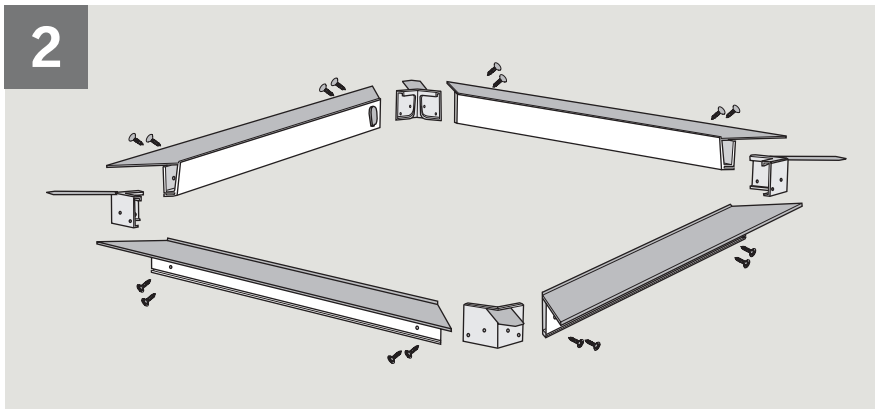
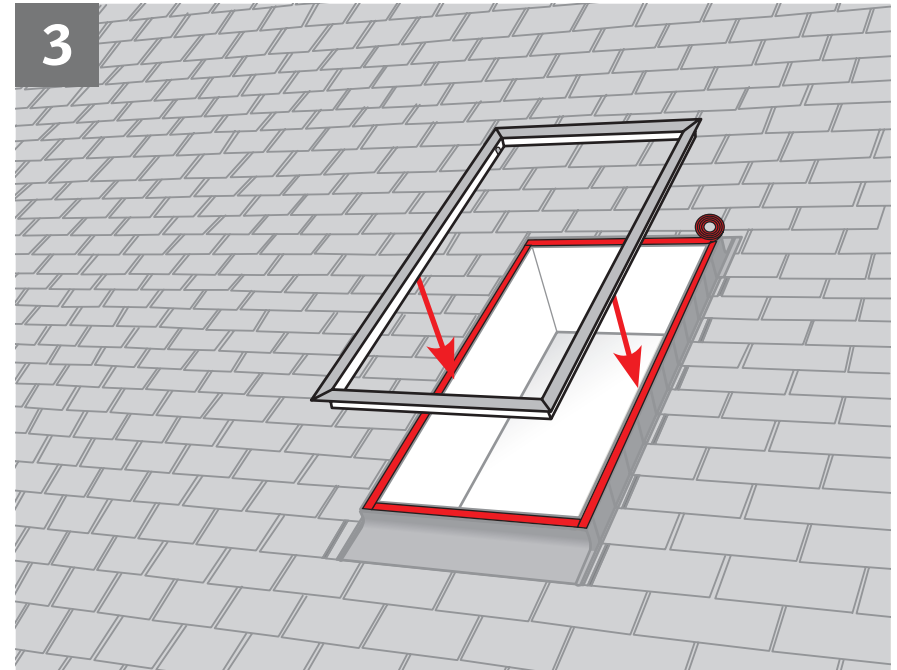
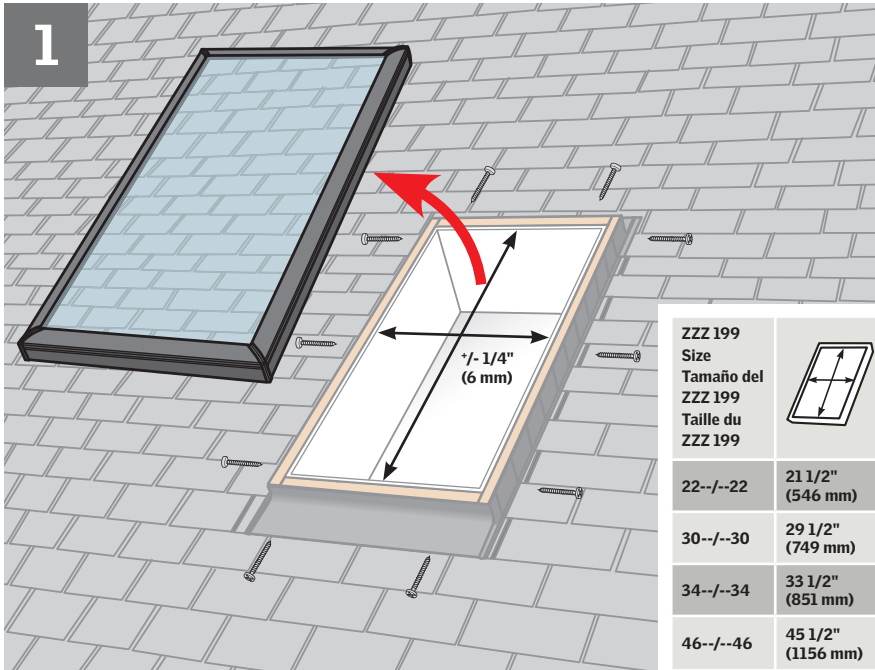

The VELUX logo consists of the word "VELUX" in a bold, white, sans-serif font, with a registered trademark symbol (®) to the upper right of the "X". The text is centered within a solid red rectangular background.

**USA:** VELUX America Inc.  
1-800-88-VELUX

**CDN:** VELUX Canada Inc.  
1 800 88-VELUX (888-3589)

**AUS:** VELUX Australia Pty. Ltd  
(02) 9550 3288

**NZ:** VELUX New Zealand Ltd.  
09-6344 126

[www.velux.com](http://www.velux.com)